

TOSHIBA

**OWNER'S MANUAL
MANUEL DU PROPRIETAIRE
BETRIEBSANLEITUNG
MANUALE DEL PROPRIETARIO
MANUAL DEL PROPIETARIO
MANUAL DO UTILIZADOR
GEBRUIKSAANWIJZING
ΟΔΗΓΙΕΣ ΧΡΗΣΗΣ
用戶手冊**

WIRED STANDARD REMOTE CONTROLLER RBC-AMT31E

Object Indoor Unit

Super Modular Multi System/ Super Heat Recovery System

<4-way Air Discharge Cassette Type>

MMU-AP0091H, AP0121H, AP0151H, AP0181H, AP0241H,
MMU-AP0271H, AP0301H, AP0361H, AP0481H, AP0561H

<2-way Air Discharge Cassette Type>

MMU-AP0071WH, AP0091WH, AP0121WH, AP0151WH, AP0181WH, AP0241WH, AP0271WH,
MMU-AP0301WH
MMU-AP0481WH (CHINA market only)

<1-way Air Discharge Cassette Type>

MMU-AP0071YH, AP0091YH, AP0121YH, AP0151SH, AP0181SH, AP0241SH

<Concealed Duct Standard Type>

MMD-AP0071BH, AP0091BH, AP0121BH, AP0151BH, AP0181BH, AP0241BH, AP0271BH,
MMD-AP0301BH, AP0361BH, AP0481BH, AP0561BH

<Concealed Duct High Static Pressure Type>

MMD-AP0181H, AP0241H, AP0271H, AP0361H, AP0481H, AP0721H, AP0961H

<Under Ceiling Type>

MMC-AP0151H, AP0181H, AP0241H, AP0271H, AP0361H, AP0481H

<High Wall Type>

MMK-AP0071H, AP0072H, AP0091H, AP0092H, AP0121H, AP0122H, AP0151H, AP0181H, AP0241H

<Floor Standing Cabinet Type>

MML-AP0071H, AP0091H, AP0121H, AP0151H, AP0181H, AP0241H

<Floor Standing Concealed Type>

MML-AP0071BH, AP0091BH, AP0121BH, AP0151BH, AP0181BH, AP0241BH

<Floor Standing Type>

MMF-AP0151H, AP0181H, AP0241H, AP0271H, AP0361H, AP0481H, AP0561H

Digital Inverter Air Conditioner

<4-way Air Discharge Cassette Type>

RAV-SM560UT-E, SM800UT-E, SM1100UT-E, SM1400UT-E
RAV-SP1100UT-E (Super Digital Inverter)

<Under Ceiling Type>

RAV-SM561CT-E, SM801CT-E, SM1101CT-E, SM1401CT-E

<Concealed Duct High Static Pressure Type>

RAV-SM561BT-E, SM801BT-E, SM1101BT-E, SM1401BT-E

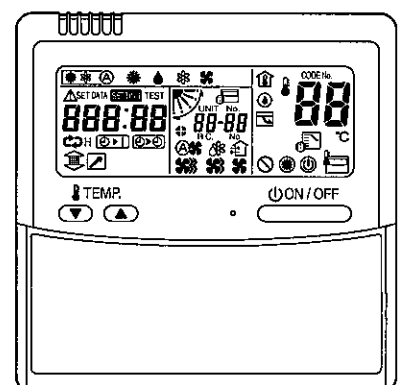

For commercial use
Pour usage commercial
Nur für gewerbliche Nutzung
Per uso commerciale
Para uso comercial
Para uso comercial
Voor commercieel gebruik
Για εμπορική χρήση
商用

ADOPTION OF NEW REFRIGERANT

This Air Conditioner is a new type which adopts a new refrigerant HFC (R410A) instead of the conventional refrigerant R22 in order to prevent destruction of the ozone layer.

CAUTION

- Before using the remote controller (RBC-AMT31E), please read this Owner's Manual.
- For installation except operation of the remote controller, refer to the Installation Manual attached to the air conditioner unit.
- To use this remote controller safely and correctly, read this Instruction Manual thoroughly before use for full understanding.
- After you read this manual, be sure to keep it so that one who uses the remote controller can read this manual anytime. If another person uses the remote controller, necessarily hand the Manual to him or her.

PRUDENCE

- Avant d'utiliser la télécommande (RBC-AMT31E), veuillez lire ce Mode d'emploi.
- Consultez le Manuel d'installation du climatiseur uniquement pour installer la télécommande, pas pour la faire fonctionner.
- Pour utiliser cette télécommande de façon correcte et sûre, lisez attentivement ce Mode d'emploi en entier.
- Lorsque vous avez fini de lire ce Mode d'emploi, rangez-le soigneusement pour pouvoir le consulter par la suite. Si une autre personne doit utiliser la télécommande, remettez-lui ce Mode d'emploi.

VORSICHT

- Lesen Sie dieses Benutzerhandbuch, bevor Sie die Fernbedienung (RBC-AMT31E) benutzen.
- Einzelheiten zur Installation der Fernbedienung finden Sie in dem dem Klimagerät beiliegenden Installationshandbuch.
- Lesen Sie das Handbuch sorgfältig, so dass Sie den Inhalt verstehen, um die Fernbedienung sicher und korrekt zu bedienen.
- Bewahren Sie das Handbuch nach dem Lesen so auf, dass jeder, der die Fernbedienung benutzen will, Zugriff auf das Handbuch hat. Will eine andere Person die Fernbedienung benutzen, händigen Sie ihr das Handbuch aus.

AVVERTENZA

- Prima di usare il telecomando (RBC-AMT31E), raccomandiamo la lettura di questo manuale d'istruzioni destinato al proprietario.
- Solo per l'installazione del telecomando, non per il funzionamento, fare riferimento al manuale di installazione fornito con il condizionatore d'aria.
- Per utilizzare il telecomando correttamente e in condizioni di sicurezza, leggere completamente questo Manuale d'istruzioni.
- Dopo aver letto questo manuale, conservarlo a portata di mano di altri che debbano poi usare il telecomando. Se un'altra persona deve usare il telecomando, raccomandare la lettura del manuale.

PRECAUCIÓN

- Lea este Manual del propietario antes de utilizar el mando a distancia (RBC-AMT31E).
- Para conocer más detalles sólo acerca de la instalación del mando a distancia, consulte el Manual de instalación que se adjunta con el aparato de aire acondicionado.
- Para utilizar este mando a distancia de manera correcta y segura, lea con atención este Manual de instrucciones antes de utilizarlo para asegurarse de que entiende totalmente su funcionamiento.
- Después de leer este manual, asegúrese de guardarlo, de modo que cualquier persona que utilice el mando a distancia pueda leerlo en cualquier momento. Si otra persona utiliza el mando a distancia, entréguele este Manual.

CUIDADO

- Antes de utilizar o controlador remoto (RBC-AMT31E), leia o presente Manual do Proprietário.
- Para pormenores acerca da instalação, excluindo o funcionamento, do controlador remoto, consulte o Manual de Instalação fornecido com o aparelho de ar condicionado.
- Para utilizar este controlador remoto em segurança e correctamente, leia atentamente o presente Manual de Instruções antes da sua utilização para um entendimento exaustivo.
- Depois da leitura do presente manual, guarde-o para que quem utilizar o controlador remoto o possa ler em qualquer altura. Se outra pessoa utilizar o controlador remoto, faculte-lhe o Manual.

LET OP

- Lees voordat u de afstandsbediening (RBC-AMT31E) gaat gebruiken eerst deze gebruiksaanwijzing.
- Meer informatie over de installatie (dus niet over de werking) van de afstandsbediening vindt u in de installatiehandleiding bij de airconditionerunit.
- Lees voor een veilig en correct gebruik van deze afstandsbediening deze handleiding aandachtig door.
- Bewaar deze handleiding, zodat u deze in de toekomst zonedig nogmaals kunt nalezen. Overhandig de handleiding, als iemand anders de afstandsbediening gebruikt, aan deze persoon.

ΠΡΟΣΟΧΗ

- Πριν χρησιμοποιήσετε το τηλεχειριστήριο (RBC-AMT31E), παρακαλούμε διαβάστε αυτό το Εγχειρίδιο Χρήσης.
- Για την εγκατάσταση, εκτός από τη λειτουργία του τηλεχειριστηρίου, δείτε το Εγχειρίδιο Εγκατάστασης που είναι προσαρτημένο στη μονάδα κλιματισμού.
- Για να χρησιμοποιήσετε αυτό το τηλεχειριστήριο με ασφαλή τρόπο και σωστά, διαβάστε προσεκτικά αυτό το Εγχειρίδιο Εγκατάστασης ώστε να κατανοήσετε καλά τη λειτουργία του.
- Αφού διαβάσετε αυτό το εγχειρίδιο, φυλάξτε το, ώστε να μπορεί ανά πάσα στιγμή να το διαβάσει κάποιος που θα χρησιμοποιήσει το τηλεχειριστήριο. Αν ένα άλλο άτομο χρησιμοποιήσει το τηλεχειριστήριο, δώστε του αυτό το Εγχειρίδιο.

注意事项

- 在使用遥控器 (RBC-AMT31E) 之前, 请先阅读此用户手册。
- 除遥控器操作之外的安装, 请参照空调机的随机安装手册。
- 为了安全正确地使用此遥控器, 在使用之前需认真阅读并完全理解此说明手册。
- 读完此手册后, 一定要妥善保管, 使遥控器的用户可以随时阅读此手册。如果其它人使用此遥控器, 则要将本手册交给该人。

CONTENTS

SAFETY CAUTION	1	ADJUSTMENT OF WIND DIRECTION	6
PARTS NAME OF REMOTE CONTROLLER	2	MAINTENANCE	10
CORRECT USAGE	4	TROUBLESHOOTING	11
TIMER OPERATION	5		

SOMMAIRE

MESURES DE SECURITE	12	REGLAGE DU SENS DE SOUFFLAGE	17
NOM DES PIECES DE LA TELECOMMANDE	13	ENTRETIEN	21
UTILISATION CORRECTE	15	DÉPANNAGE	22
FONCTIONNEMENT PAR MINUTERIE	16		

INHALT

SICHERHEITSHINWEISE	23	EINSTELLUNG DES LUFTSTROMS	28
TEILEBEZEICHNUNG DER FERNBEDIENUNG	24	WARTUNG	32
RICHTIGE HANDHABUNG	26	FEHLERSUCHE	33
ZEITBETRIEB	27		

INDICE

PRECAUZIONI DI SICUREZZA	34	REGOLAZIONE DELLA DIREZIONE DELL'ARIA	39
NOME DELLE PARTI DEL TELECOMANDO	35	MANUTENZIONE	43
USO CORRETTO	37	RISOLUZIONE DEI PROBLEMI	44
FUNZIONAMENTO CONTIMER	38		

CONTENIDO

PRECAUCIONES DE SEGURIDAD	45	FUNCIÓNAMIENTO DEL TEMPORIZADOR	49
DESCRIPCIÓN DE LOS BOTONES DEL CONTROL REMOTO	46	AJUSTE DE LA DIRECCIÓN DEL AIRE	50
UTILIZACIÓN CORRECTA	48	MANTENIMIENTO	54
		RESOLUCIÓN DE PROBLEMAS	55

ÍNDICE

PRECAUÇÃO DE SEGURANÇA	56	REGULAÇÃO DA DIRECÇÃO DO VENTO	61
NOME DAS PEÇAS DO CONTROLADOR REMOTO	57	MANUTENÇÃO	65
UTILIZAÇÃO CORRECTA	59	RESOLUÇÃO DE PROBLEMAS	66
OPERAÇÃO DO TEMPORIZADOR	60		

INHOUD

AANDACHTSPUNTEN VOOR UW VEILIGHEID	67	DE TIMER GEBRUIKEN	71
BENAMING VAN DE ONDERDELEN VAN DE AFSTANDBEDIENING	68	INSTELLEN VAN DE LUCHTSTROOMRICHTING	72
CORRECT GEBRUIK	70	ONDERHOUD	76
		STORINGEN VERHELPEEN	77

ΠΕΡΙΕΧΟΜΕΝΑ

ΠΡΟΦΥΛΑΞΕΙΣ ΓΙΑ ΤΗΝ ΑΣΦΑΛΕΙΑ	78	ΡΥΘΜΙΣΗ ΤΗΣ ΚΑΤΕΥΘΥΝΣΗΣ ΤΟΥ ΑΝΕΜΟΥ	83
ΟΝΟΜΑΣΙΑ ΤΜΗΜΑΤΩΝ ΤΟΥ ΤΗΛΕΧΕΙΡΙΣΤΗΡΙΟΥ	79	ΣΥΝΤΗΡΗΣΗ	87
ΟΡΘΗ ΧΡΗΣΗ	81	ΑΝΤΙΜΕΤΩΠΙΣΗ ΠΡΟΒΛΗΜΑΤΩΝ	88
ΛΕΙΤΟΥΡΓΙΑ ΧΡΟΝΟΔΙΑΚΟΠΤΗ	82		

目 录

安全注意事项	89	风向调节	94
遥控器部件的名称	90	维护	98
正确的使用方法	92	故障处理	99
定时器运转	93		

SAFETY CAUTION

- Please read this “Safety Cautions” thoroughly before installation to install the air conditioner correctly.
- The important contents concerned to the safety are described in the “Safety Cautions”. Be sure to keep them. For Indications and their meanings, see the following description.

■ Explanation of indications

WARNING

Indicates possibilities that a death or serious injury of personnel is caused by an incorrect handling.

CAUTION

Indicates contents that an injury (*1) or property damage (*2) only may be caused when an incorrect work has been executed.

- *1 : “Injury” means a hurt, a burn, or an electric shock which does not require hospitalization or a long-term going to the hospital.
- *2 : “Property damage” means an enlarged damage concerned to property, or breakage of materials.

- **After installation work has finished, check there is no trouble by a test operation, and explain using method and maintenance method to the customers based on the Owner’s Manual.**
Please ask the customers to keep this Installation Manual together with the Owner’s Manual.
- **Make sure to ask the qualified installation professional in electric work to install the air conditioner.**
If the air conditioner is inappropriate installed by yourself, it may cause water leak, electric shock, fire, and so on.
- **A person qualified for the electric work should deal with the electric construction conforming to the regulations of the local electric company and the Installation Manual.**
Be sure to use the exclusive circuit.
If there is capacity shortage of the power supply circuit or incomplete installation, a fire or an electric shock is caused.
- **For wiring, use the specified wires and connect them securely so that external force of wire does not transmit to the terminal connecting section.**
If connection or fixing is incomplete, a fire, etc may be caused.
- **For the products sold separately, be sure to use those specified by us.**
Be sure to use the products sold separately which are specified by us; otherwise a fire, an electric shock, or water leak may be caused. Moreover ask an expert to install the air conditioner.
- **When you notice something abnormal with the air conditioner (smells like something scorching, poor cooling, etc.), immediately turn off the main switch, the circuit breaker, from the mains to stop the air conditioner, and contact the dealer.**
If the air conditioner is continuously operated with something abnormal, it may cause machine failure, electric shock, fire, and so on.
- **Do not touch the switches with the wet hands.**
Otherwise an electric shock may be caused.
- **When cleaning the air conditioner, be sure to stop the operation and turn off the power switch.**
Otherwise an injury may be caused because the fan rotates in high speed inside of the air conditioner.

PARTS NAME OF REMOTE CONTROLLER

Display section

In the display example, all indicators are displayed for the explanation.
In reality only, the selected contents are indicated.

- When turning on the leak breaker at the first time, [SET DATA] flashes on the display part of the remote controller. While this display is flashing, the model is being automatically confirmed. Accordingly, wait for a while after [SET DATA] display has disappeared, and then use the remote controller.

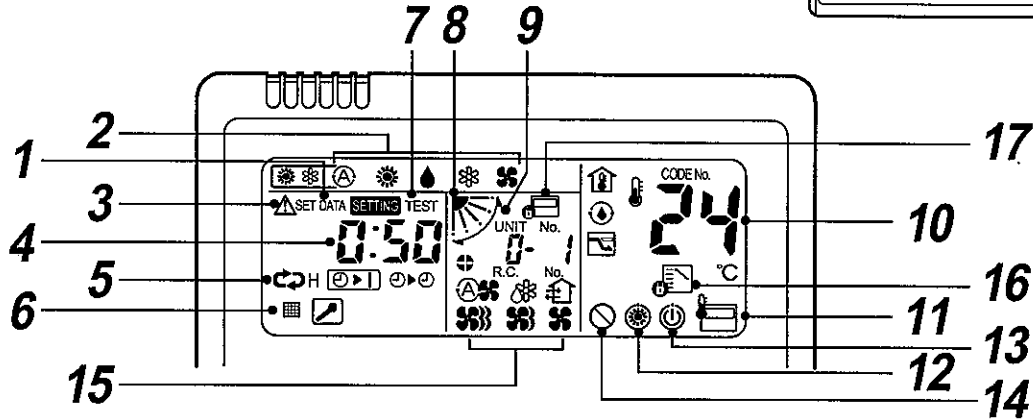
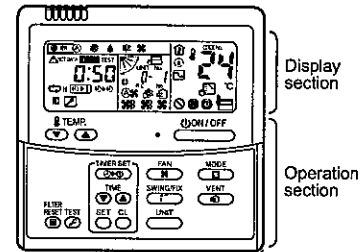

- 1 SET DATA display**
Displayed during setup of the timer.
- 2 Operation mode select display**
The selected operation mode is displayed.
- 3 CHECK display**
Displayed while the protective device works or a trouble occurs.
- 4 Timer time display**
Time of the timer is displayed.
(When a trouble occurs, the check code is displayed.)
- 5 Timer SETIN setup display**
When pushing the Timer SETIN button, the display of the timer is selected in order of [OFF] [ON] → [OFF] repeat OFF timer → [ON] → No display.
- 6 Filter display**
If "FILTER" is displayed, clean the air filter.
- 7 TEST run display**
Displayed during a test run.
- 8 Flap position display**
(for 4-Way Air Discharge Cassette Type and Under Ceiling Type model only)
Displays flap position.
- 9 SWING display**
Displayed during up/down movement of the flap.
- 10 Set up temperature display**
The selected set up temp. is displayed.
- 11 Remote controller sensor display**
Displayed while the sensor of the remote controller is used.
- 12 PRE-HEAT display**
(for Heat-pump model only)
Displayed when the heating operation starts or defrost operation is carried out.
While this indication is displayed, the indoor fan stops or the mode enters in LOW.
- 13 Operation ready display**
Displayed when cooling or heating operation is impossible because the outdoor temperature goes out of the operable range.
- 14 No function display**
Displayed if there is no function even if the button is pushed.
- 15 Air volume select display**
The selected air volume mode is displayed.
(AUTO) (A) (HIGH) (MED.) (LOW)
- 16 Mode select control display**
Displayed when pushing "Operation mode select" button while the operation mode is fixed to heating or cooling by the system manager of the air conditioner.
- 17 Central control display**
Displayed when using the remote controller together with the central control remote controller, etc.
If Remote controller is prohibited at the centralcontrol side, flashes when operating (ON/OFF) (MODE) (DOWN) / (UP) buttons and the change is not accepted.
(The contents available to be set up on the remote controller differ according to the central control mode. For details, refer to Owner's Manual of the central control remote controller.)

Operation section

Push each button to select a desired operation.

This remote controller can operate the maximum 8 indoor units.

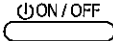
- The details of the operation needs to be set up once, afterward, the air conditioner can be used by pushing  button only.

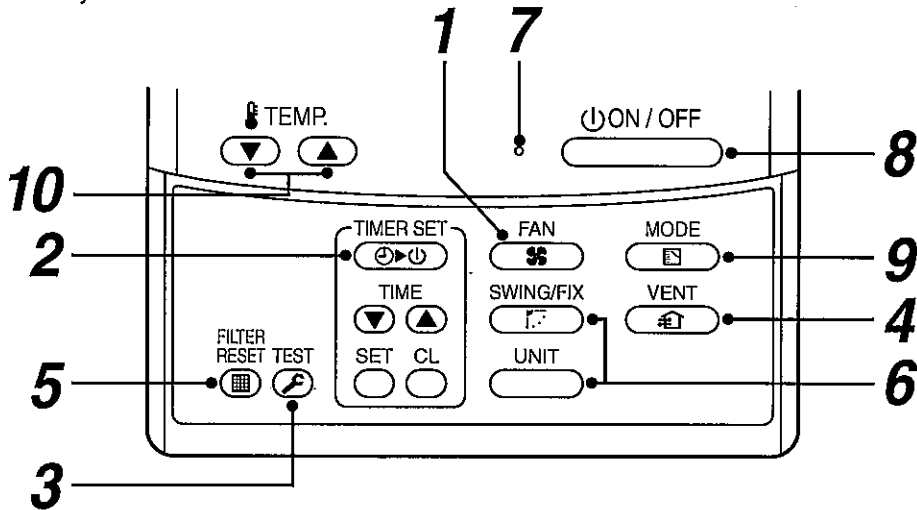

1 Air volume select button

Selects the desired air volume mode.

The Concealed Duct High Static Pressure type models cannot be operated.

2 Timer set button

TIMER SET button is used when the timer is set up.

3 Check button

The CHECK button is used for the check operation. During normal operation, do not use this button.

4 Fan button

FAN button is used when a fan which is sold on the market or etc. is connected.

- If  is displayed on the remote controller when pushing the FAN button, a fan is not connected.

5 Filter reset button

Resets (Erases) "FILTER  display.

6 Wind direction and Swing

 :

If the multiple indoor units are operated by only one remote controller, select the units when the air direction is adjusted.

 :

Set up the auto swing and angle of the flap.

- This function is not provided to Concealed Duct Standard Type, High Static Pressure Type, Floor standing Cabinet Type, Floor Standing Concealed Type, or Slim Duct Type.

7 Operation lamp

Lamp is lit during the operation. Lamp is off when stopped.

Although it flashes when operating the protection device or abnormal time.

8 button

When the button is pushed, the operation starts, and it stops by pushing the button again.



When the operation has stopped, the operation lamp and all the displays disappear.

9 Operation select button

Selects desired operation mode.

10 Set up temperature button

Adjusts the room temperature.

Set the desired set temperature by pushing  or  .

Remote controller sensor

Usually the TEMP. sensor of the indoor unit senses the temperature. The temperature on the surrounding of the remote controller can also be sensed. For details, contact the dealer from which you have purchased the air conditioner.

- In case that one remote controller controls the multiple indoor units, the setup operation is unavailable in group control.

CORRECT USAGE

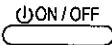
When you use the air conditioner for the first time or when you change the SET DATA value, follow the procedure below. From the next time, the operation displayed on the remote controller will start by pushing the  button only.

Preparation

Turn on the main power switch and/or the leakage breaker.

- When the power supply is turned on, a partition line is displayed on the display part of the remote controller.
- * After the power supply is turned on, the remote controller does not accept an operation for approx. 1 minute, but it is not a failure.

REQUIREMENT

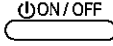
- While using the air conditioner, operate it only with  button without turning off the main power switch and the leak breaker.
- Do not turn off the leak breaker while the air conditioner is used.
- Turn on the leak breaker 12 hours or more before start of operation after the air conditioner has stopped for a long time.

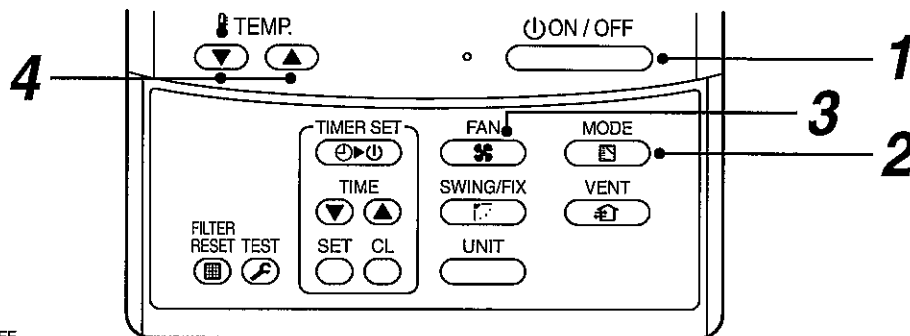

1 Push button.

The operation lamp goes on, and the operation starts.

2 Select an operation mode with the button.

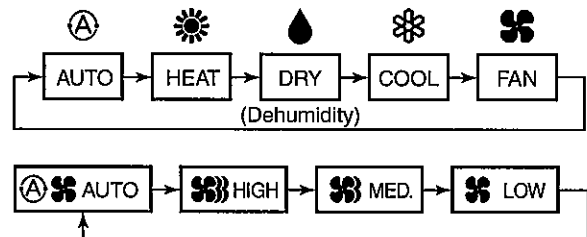

One push of the button, and the display changes in the order shown on the right.

- “DRY  mode” function is not provided to Concealed Duct High Static Pressure Type.



3 Select air volume with button.

One push of the button, and the display changes in the order shown on the right.

- When air volume is “AUTO  mode, “AUTO 

4 Determine the set up temperature by pushing the “TEMP. Stop

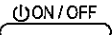
Push  button.

The operation lamp goes off, and the operation stops.

TIMER OPERATION

A type of timer operation can be selected from the following three types.

- OFF timer : The operation stops when the time of timer has reached the set time.
- Repeat OFF timer : Every time, the operation stops after the set time has passed.
- ON timer : The operation starts when the time of timer has reached the set time.

Timer operation

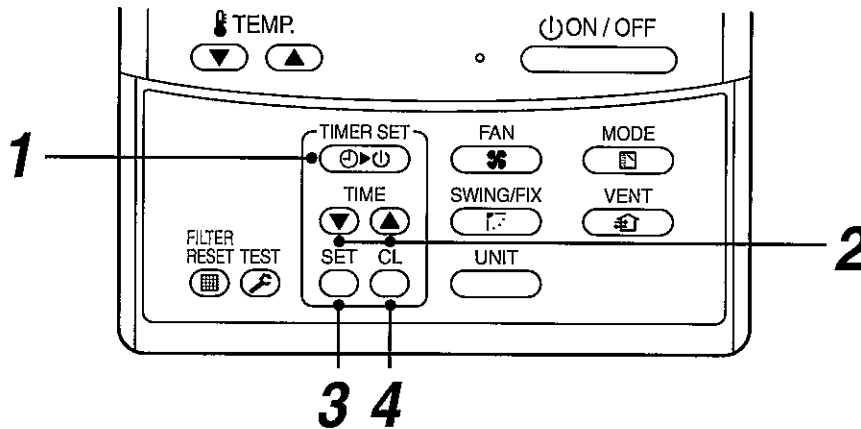

1 Push TIMER SET button.

- The timer display (type) changes for every push of the button.
- SET DATA and display flashes.

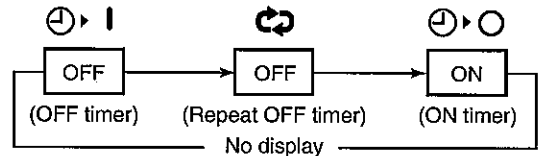

2 Push to select "SET TIME".

Every pushing button, the setup time increases in the unit of 0.5 hr (30 minutes).
For the setup time above 1d (24 hr), time increases in the unit of 1 hr.
The maximum setup time is 7d (168 hr).

On the remote controller, the setup time is displayed with numerals for 0.5 hr to 23.5 hr (*1), and time over 24 hr (*2) is displayed by No. of days and time.

Every pushing button, the setup time is decreased in the unit of 0.5 hr (30 minutes) (From 0.5 hr to 23.5 hr) or in the unit of 1 hr (From 24 hr to 168 hr).

Display example of remote controller

- Case of 23.5 hr (*1)
- Case of 34 hr (*2)

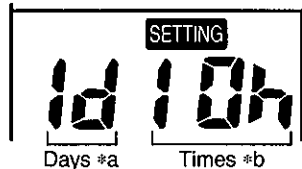

- *a: Represents a day (24 hr).
- *b: Represents 10 hours (Total 34 hours).

3 Push SET button.

- SET DATA display disappears and display goes on.
(When ON timer is activated, time is displayed, and after time of the timer has been up, displays other than ON disappear.)

Cancel of timer operation

4 Push CL button.

- TIMER display disappears.

NOTICE

- When the operation stops after the timer reached the preset time, the Repeat OFF timer resumes the operation by pushing button and stops the operation after the time of the timer has reached the set time.

ADJUSTMENT OF WIND DIRECTION

To increase the cooling or heating effect, be sure to use the discharge flap in the different directions in cooling or heating operation.

As the characteristics of the air, the cold air accumulates at lower side and hot air at upper side, respectively.

⚠ CAUTION

Set the louver horizontally in cooling operation.

If cooling operation is performed with downward discharge, the surface of the discharge port or louver will be wet with dew, and dewdrop may fall down.

REQUIREMENT

- If heating operation is performed with horizontal discharge, unevenness of temperature may increase in the room.

4-way Air Discharge Cassette, Under Ceiling Type

- While the air conditioner stops, the discharge flap automatically directs downward.
- While the air conditioner is in ready status for heating, the discharge flap directs upward.
The swinging operation starts after heating ready status has been cleared, but "SWING ↷" is displayed on the remote controller even if the status is ready to heating.

[In Cooling operation]

Use the discharge flap with horizontal set point.

[In Heating operation (For Heat-pump model only)]

Use the discharge flap with downward set point.

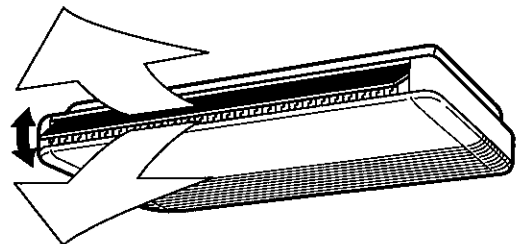
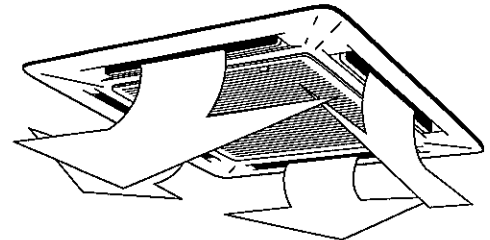
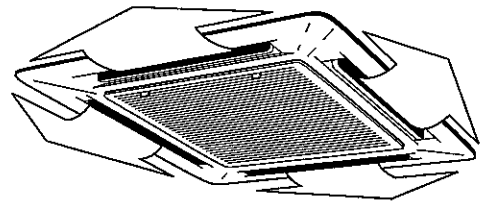

How to set up the air direction

Push  button.

1 Every pushing the button, the air direction changes.

In Heating operation

Set the air outlet flap downward.
If directing it upward, the hot air may not come to the foot.

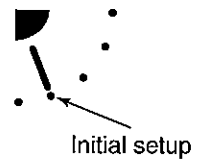

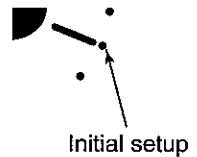

In Cooling / Dry operation

Set the air outlet flap upward.
If directing it downward, the dew may fall on near the air discharge port or it drips.



How to start swinging

2 Push  button.

Set direction of the air outlet flap to the lowest position and then push  button again.

- [SWING ] is displayed and the air direction automatically changes upward/downward.

In case when one remote controller controls the multiple indoor units, each indoor unit can be selected and its air direction can be set up.

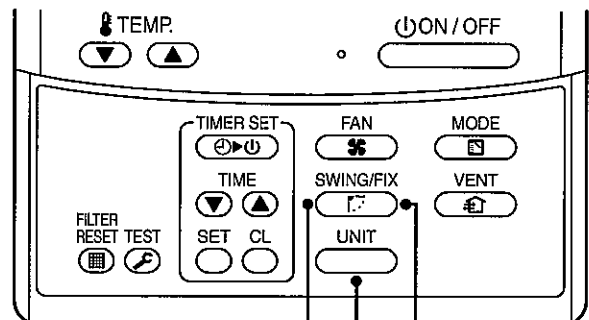

1, 2, 3 — 4



How to stop swinging

3 Push  button again during swinging of the air outlet flap.

- The air outlet flap can be stopped at the desired position. After then the air direction can be again set up from the uppermost position by pushing  button.

* While the air outlet flap is set downward in cooling/drying operation, it does not stop. If stopping the air outlet flap which directs downward during swinging, it stops after moving to the 3rd position from the top position.

4 

- To set up the air direction individually, push  button to display each indoor unit No. in a group control. Then set up the air direction to a displayed indoor unit.
- If there is no display, all the indoor units can be operated collectively.
- Every pushing  button, the display exchanges as shown in the figure.

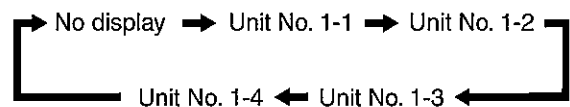
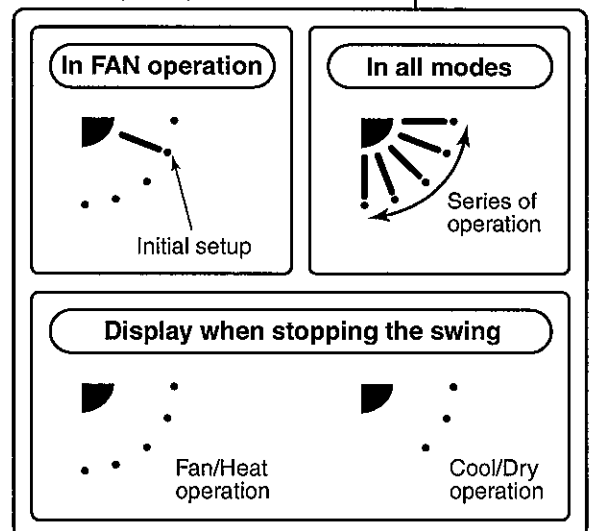

According to the shape or arrangement of the room, the cold air and hot air can be discharged for two directions or three directions. For details, contact the dealer.

INFORMATION

- If cooling operation is performed with downward discharge, dew may fall on surface of the cabinet or the horizontal flap resulted in dripping.
- If heating operation is performed with horizontal discharge, unevenness of temperature may increase in the room.
- Do not move the horizontal flap directly with hands; otherwise a trouble is caused. Select direction of the horizontal flap using flap operation switch on the remote controller. The horizontal flap does not stop immediately even if the switch is pushed. Adjusting the stop position, push the switch.

2-way Air Discharge Cassette, 1-way Air Discharge Cassette, Floor Standing, High Wall Type

[In Cooling operation]

Use the air outlet flap with horizontal set point.

[In Heating operation (For Heat-pump model only)]

Use the air outlet flap with downward set point.

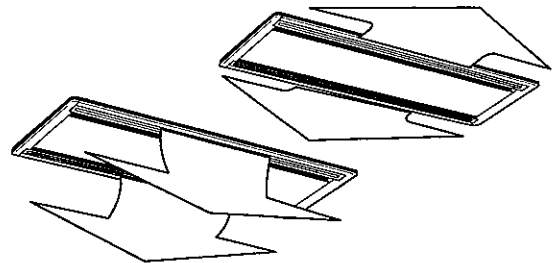

Setup of air direction and swinging

1 Push **SWING/FIX** button during operation.

- [SWING] is displayed and the air direction automatically changes upward/downward.

In case when one remote controller controls the multiple indoor units, each indoor unit can be selected and its air direction can be set up.

2 Push **SWING/FIX** button again during swinging of the air outlet flapp.

- The air outlet flap can be stopped at the desired position.

3 **UNIT**

- To set up the air direction individually, push **UNIT** button to display each indoor unit No. in a group control. Then set up the air direction to a displayed indoor unit.
- If there is no display, all the indoor units can be operated collectively.
- Every pushing **UNIT** button, the display exchanges as shown in the figure.

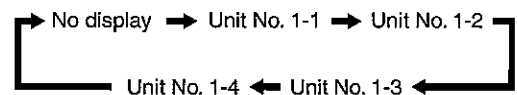
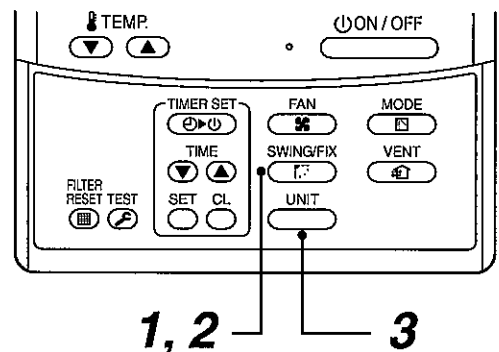

1-way Air Discharge Cassette Type

Adjustment of air direction upward/downward

[In Cooling operation]

In cooling operation, use the air outlet flap with horizontal set point so that the cold air diffuses in whole room.

[In Heating operation (For Heat-pump model only)]

In heating operation, use the air outlet flap with downward set point so that the hot air blows at the foot.

Adjustment of air direction rightward/leftward

To change the discharge direction to right or left side, set the vertical grille inside of the air outlet flap to the desired direction.

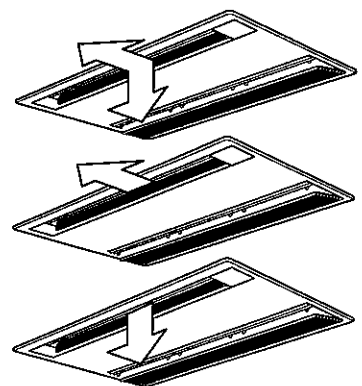

Setup of air direction and swinging

Refer to description of "2-way Air Discharge Cassette Type".

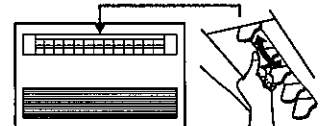

Right/Left air direction adjustment

To change the air outlet direction to right or left side, set the vertical flap inside of the horizontal flap to the desired direction.

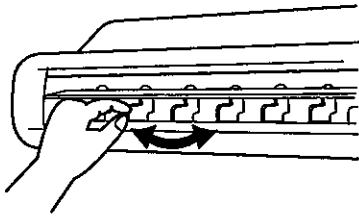

INFORMATION

- If cooling operation is performed with downward discharge, dew may fall on surface of the cabinet or the horizontal flap resulted in dripping.
- If heating operation is performed with horizontal discharge, unevenness of temperature may increase in the room.

High Wall Type

Adjustment of air direction upward/downward

[In Cooling operation]

In cooling operation, use the horizontal flap with horizontal set point so that the cold air diffuses in whole room.

[In Heating operation (For Heat-pump model only)]

In heating operation, use the horizontal flap with downward set point so that the hot air blows at the foot.

REQUIREMENT

- If cooling operation is performed with downward air outlet, dew may fall on surface of the cabinet or the horizontal flap resulted in dripping.
- If heating operation is performed with horizontal air outlet, unevenness of temperature may increase in the room.

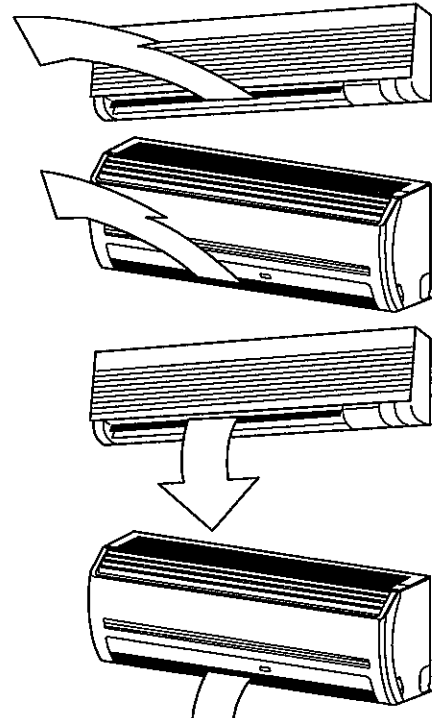

Floor Standing Type

Adjustment of air direction upward/downward

[In Cooling operation]

In cooling operation, move the flap with hands and use it with horizontal air outlet point so that the cold air diffuses in whole room.

[In Heating operation (For Heat-pump model only)]

In heating operation, move the flap with hands and use the horizontal flap with downward set point so that the hot air blows at the foot.

Adjustment of air direction rightward/leftward

[In case of using unsymmetrical air directions]

Lift up the vertical flap lightly, direct it toward the desired direction, and lower it.

In this case, do not use the Swing function.

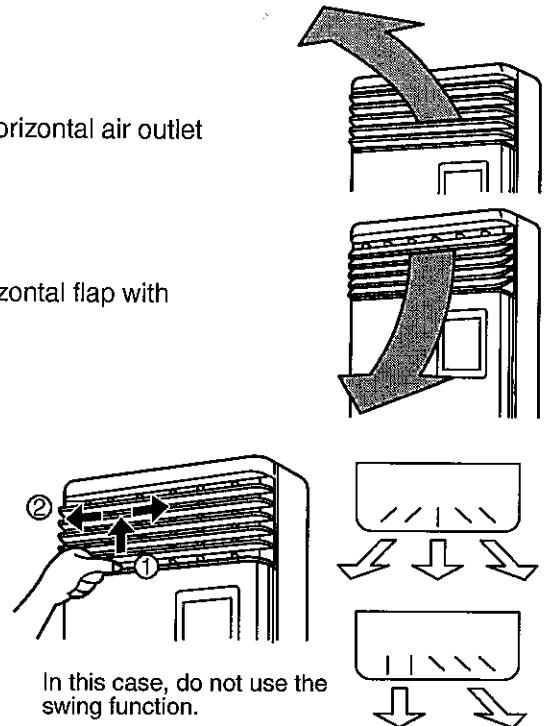

MAINTENANCE

Cleaning of air filter

- When [FILTER] is displayed on the remote controller, maintain the air filter.
- Clogging of air filter decreases cooling/heating effect.

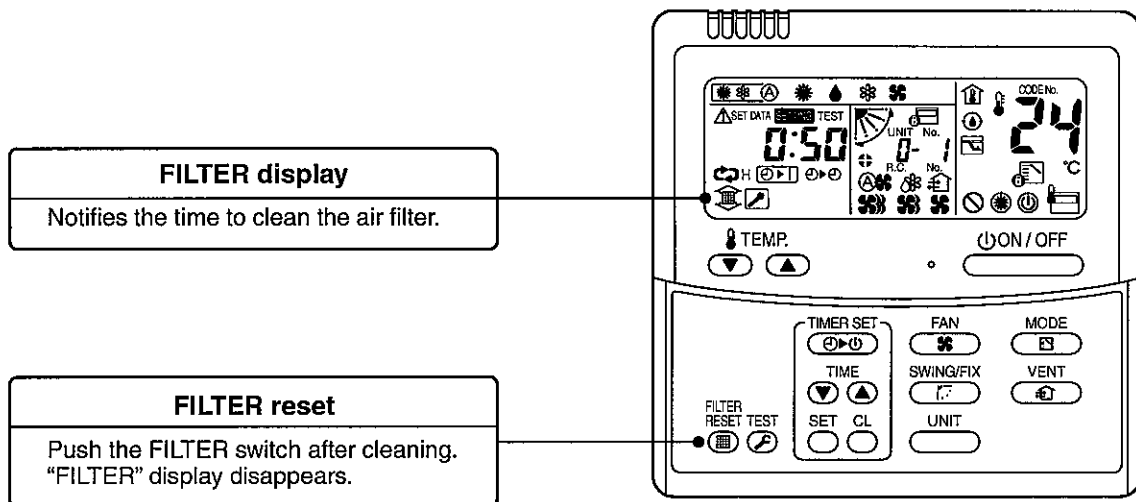

WARNING

Be sure to turn off the main power switch prior to the maintenance.

- Please do not intend to do the daily maintenance and/or Air Filter cleaning by yourself.

Cleaning of the air filter and other parts of the air filter involves dangerous work in high places, so be sure to have a service person do it. Do not attempt it yourself.

TROUBLESHOOTING

Confirmation and check

When a trouble occurred in the air conditioner, the check code and the indoor unit No. appear on the display part of the remote controller.

The check code is only displayed during the operation.

If the display disappears, operate the air conditioner according to the following "Confirmation of error history" for confirmation.

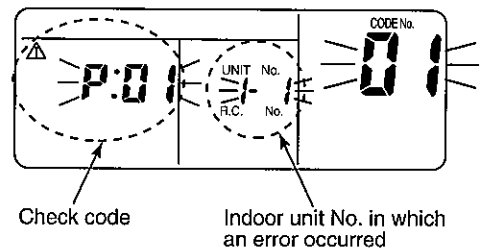

Confirmation of error history

When a trouble occurred on the air conditioner, the trouble history can be confirmed with the following procedure. (The trouble history is stored in memory up to 4 troubles.)

The history can be confirmed from both operating status and stop status.

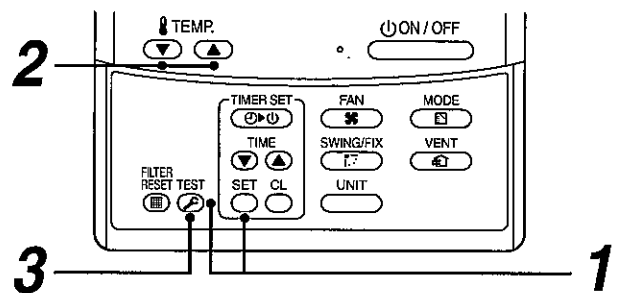

Procedure	Description
1	<p>When pushing SET and TEST buttons at the same time for 4 seconds or more, the following display appears.</p> <p>If [Service check] is displayed, the mode enters in the trouble history mode.</p> <ul style="list-style-type: none"> • [01 : Order of trouble history] is displayed in CODE No. window. • [Check code] is displayed in CHECK window. • [Indoor unit address in which an error occurred] is displayed in UNIT No.
2	<p>Every pushing of TEMP. (▼), TEMP. (▲) button used to set temperature, the trouble history stored in memory is displayed in order.</p> <p>The numbers in CODE No. indicate CODE No. [01] (latest) → [04] (oldest).</p> <p>CAUTION</p> <p>Do not push CL button because all the trouble history of the indoor unit will be deleted.</p>
3	<p>After confirmation, push TEST button to return to the usual display.</p>

1. Check the troubles according to the above procedure.
2. Ask an authorized dealer or qualified service (maintenance) professional to repair or maintain the air conditioner.
3. More details of the service code are explained in Service Manual.

TOSHIBA CARRIER CORPORATION
2 CHOME 12-32, KONAN, MINATOKU, TOKYO, 108-0075, JAPAN